

Peg Perego

USA

EN Instructions for use

FIUS23011356

PRIMO VIAGGIO 4-35 URBAN MOBILITY

WARNING:

Do not install or use this child restraint until you read and understand all instructions in this manual. To avoid serious injuries to your baby, follow the instructions carefully and be sure to buckle your baby using the 5-point harness.

Child Requirements:

Weight limits: 4 - 22 lbs (1.8 - 10 kg) with LATCH

Weight limits: 4 - 35 lbs (1.8 - 15.9 kg) with VEHICLE BELT

Maximum height: 32 inches (81.3 cm)



DA AGGIORNARE

Table of Contents

Before You Start	page 3	- using a lap/shoulder INFLATABLE SHOULDER BELT	page 35
Customer Service/Registration Form	page 4	Installing the Base with different Types of Seat Belts	page 36
Safety Rules	page 5	Installing the Car Seat:	
Your Car Seat	page 8	- on the Base	page 37
Your Car Seat Base	page 10	- without the Base	page 39
Travel System	page 11	- with different Types of Seat Belts	page 41
Serial Numbers	page 12	Use of a Locking Clip	page 42
Assembly before first use	page 13	How to buckle your baby into the Car Seat	page 43
Installation Instructions	page 14	How to raise or lower the Shoulder Straps	page 48
LATCH SYSTEM overview	page 15	Kinetic Pods	page 50
Vehicle seat belt overview	page 16	Dual Cushion System	page 51
Non compatible seatbelt designs or seating positions	page 24	Using the Car Seat outside the Vehicle	page 52
Installing the Base	page 25	How to use the Car Seat on Aircraft	page 54
Using the load leg	page 26	Cleaning and Maintenance	page 55
How to level the base in the vehicle	page 27	How to wash the chair padding	
How to Install the Base:		- Cover removal	page 56
- using the LATCH SYSTEM	page 28	- Refitting	page 59
- your VEHICLE SEAT BELT	page 32	Replacement Parts	page 61

Before You Start

- 1** Please read this manual carefully. Keep the manual for future reference.
- 2** Review car seat parts and read through instructions. Read and understand the labels and all the instructions before using this car seat.
- 3** Fill in and return the registration form (see page 4).
- 4** All assembly must be performed by an adult.
- 5** Do not use the car seat if damaged or parts are missing.
- 6** Use only parts or accessories approved by Peg-Perego. Do not modify or repair any part.
- 7** Remember: this car seat is to be installed rear facing only.
- 8** Peg-Perego has the right to make changes to the product at any time without notice.

Customer Service

Call Peg Perego USA Customer Service at 1-800-671-1701 (toll free) for information about repairs or spare parts. If any part is missing or damaged, replace with Peg Perego parts only. See page 60 for a list of replacement parts.

Registration Form

Important! Child restraints could be recalled for safety reasons. You must register this restraint to be reached in a recall. Send your name, address and the restraint's model number and manufacturing date to:

Peg-Perego U.S.A., Inc.
3625 Independence Drive
Fort Wayne, IN 46808
Or call 1-800-671-1701 (toll free)
Or register online at
www.carseat-registration.pegperego.com

For recall information, call the U.S. Government's Vehicle Safety Hotline at 1-888-327-4236 (TTY: 1-800-424-9153). Or go to <http://www.NHTSA.gov>

Important! This information is already available on the registration form attached to your new car seat. All that you can do is tear off the part indicated and send through ordinary mail. We have already paid for it. Complete and send in the registration form right away.

Safety Rules

WARNING

- This car seat meets or exceeds all applicable Federal Motor Vehicle Safety Standard 213 requirements for use in motor vehicles and aircraft.
 - **Read all instructions before use. Keep instructions for future reference.**
 - Your child could be seriously injured if you do not follow instructions and warning labels correctly.
 - Use this car seat rear facing only. This seat is not designed to face forward. Serious injury or death can occur in an accident if you install the seat facing forward.
 - If your vehicle has air bags, do not install this car seat on a sitting position equipped with an active air bag. In case of air bag deployment the restraint could be hit with severe force. Death or serious injuries can occur to the restraint occupant.
 - If your vehicle is equipped with air bags, refer to your Vehicle Owner's Manual for instructions on where to install a child car seat.
- **Do not install this car seat if your vehicle is equipped with an inflatable shoulder belt .** For additional information, please refer to your Vehicle Owner's Manual.
 - Owners of vehicles with front (or rear) passenger side air bags should refer to their Vehicle Owner's Manual for child restraint installation instructions.
 - **This car seat is certified for use without base. A base can be purchased as an additional accessory (not included).**



Safety Rules

WARNING

- Never install the car seat in the front vehicle seat unless instructed by your vehicle manual. According to accident statistics, children are safer when properly restrained in the rear seating positions than in the front seating positions.
- NEVER leave the child unattended.
- Always buckle your baby into the car seat with the harness. Be sure to latch buckles correctly.
- Fall hazard: child's activity can move carrier. NEVER place carrier on countertops, table or any other elevated surface.
- Do not use in the seating area or across the top of shopping carts.
- Suffocation hazard: child carrier can roll over on soft surfaces and suffocate child. NEVER place carrier on beds, sofas or other soft surfaces.
- Strangulation hazard: children have STRANGLED in loose or partially buckled harness straps. Fully restrain the child even when carrier is used outside the vehicle.
- In case of accident: if this car seat is involved in a car accident, it may be no longer safe to use. You may need to get a new unit. Call customer service at 1-800-671-1701 (toll free) for more information.
- Do not use this carrier if it is broken or damaged.
- **When lifting the seat, be sure you first secure the handle into the carrying position.**
- Keep fingers away from moving parts.

Safety Rules



WARNING

- Use only with children who weigh between 4 and 35 pounds (1.8 and 15.9 kg) and whose height is 32 inches (81.3 cm) or less. If your baby was born with low birth weight, ask your doctor for special instructions on using a child car seat.
- Never leave your baby alone in the car seat. He/she could get tangled in the straps and be seriously injured or could move or tip the seat.
- Install this car seat on front facing seats only. Do not use on rear facing or side facing seats or in cars with door-mounted or motorized shoulder belts.
- Use this car seat in vehicles with standard lap or lap/shoulder belts or universal lower anchors. Read your vehicle manual to locate the lower anchors.
- Be sure the car seat is properly leveled. If the car seat reclines too much, your baby can be injured or ejected from the seat. If the car seat is too upright, it can cause your baby to have breathing problems, which could lead to injury or death.
- Do not leave the car seat or base unsecured in the vehicle, even if not occupied. A loose car seat can injure other passengers in a crash.
- Do not use this unit after seven (7) years from the date of purchasing. If a purchase proof is not available, refer to the production date labeled on the seat.
- Do not hang toys on handle of seat.
- Use only approved parts. Use of unapproved parts can affect the safety of the car seat and cause serious injury or death in an accident.

Your Car Seat

PAGODA HOOD

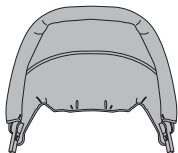

5 POINT HARNESS SYSTEM

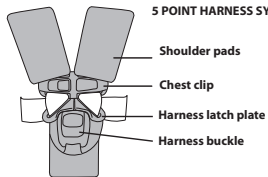

FRONT

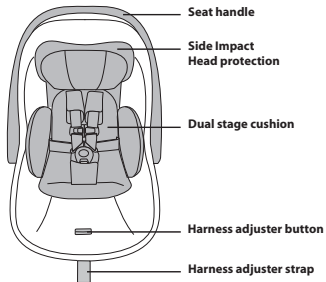

BACK

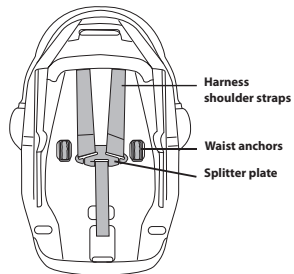

Your Car Seat

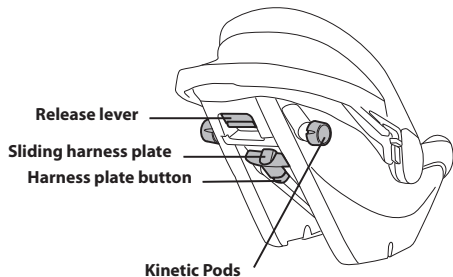

Energy absorbing
Expanded Polypropylene (EPP)
foam lined headrest.

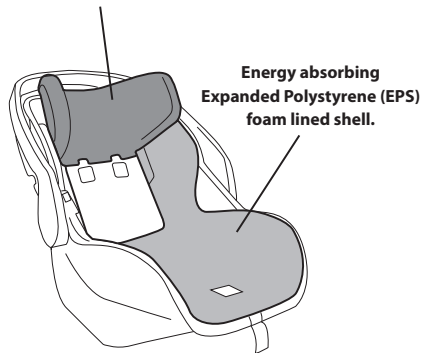

Travel System

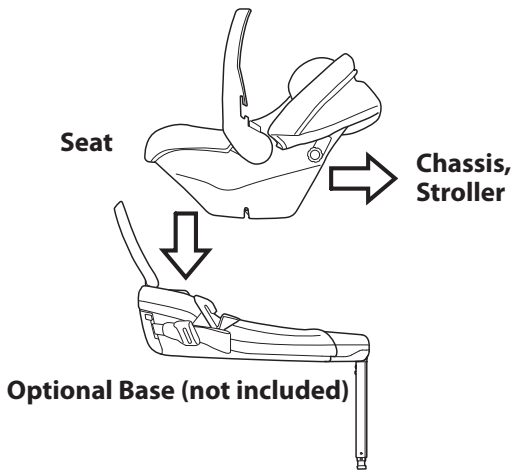

Serial Numbers

The product identity label is located on the inner structure on the car seat as shown in the picture. The label carries the following information: product name, production date and serial number, which identify your product uniquely.

Every buckle and harness used on this car seat is marked with a production serial number located as shown in the pictures.

In the event of problems with the product, these details may be requested by Peg Perego Customer Service.

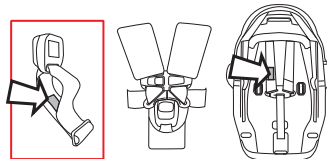
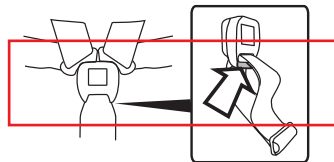

capire dove sono i seriali

Installation Instructions

Peg Perego **Primo Viaggio 4-35 Urban Mobility** is certified for use with or without the base.

For installation instructions without the base, refer to section at page **23**.

For installation instructions with the base, refer to section at page **31**.

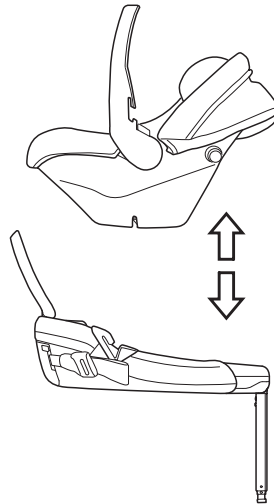

LATCH SYSTEM overview

This car seat is equipped with latch connectors (refer to [page 23](#) for latch operation). Latches must be connected to your vehicle latch anchors located at the junction of the seat and backrest in your vehicle seat. There are two anchors for each seating position and they are spaced by about 11" (28 cm). They may be visible or slightly recessed into the vehicle upholstery and can be protected by plastic or fabric shields. The LATCH anchor can be located by this symbol:



Check your Vehicle Owner's Manual to find the LATCH anchor locations in your vehicle and the possible combinations of use of a child restraint in it.

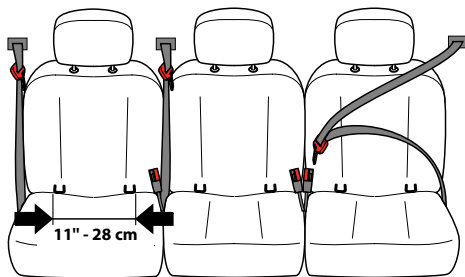

Vehicle seat belt overview

VEHICLE SEATBELTS: this car child seat is designed to be installed with vehicle belts. There are many different vehicle belt designs. Unfortunately, some may be unsuitable for a safe installation of this car seat. Please read carefully the pages below.

Check your Vehicle Owner's Manual or call Peg-Perego Customer Service @ 1-800-671-1701 for additional help.

The most common vehicle belt is composed of a web strap (a), a latch plate (b), a buckle (c) and a retractor (d). A retractor is a spring loaded device that rolls the seatbelt automatically when not in use. Common retractors are:

Emergency Locking Retractor (ELR) allows the occupant to have free movement while buckled up, but in an emergency situation or crash the retractor instantly locks securing the occupant.

Switchable Locking Retractor (ELR → ALR)
Switches from Emergency Locking Retractor (ELR) to an Automatic Locking Retractor (ALR). This allows the user to lock the retractor at a set position (also called child restraint mode) used for securing child seats.

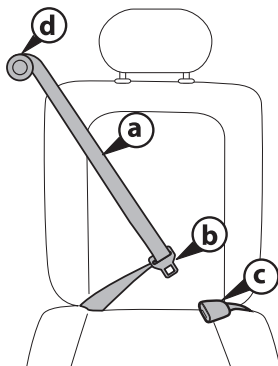

Vehicle seat belt overview

ALR mode is activated by extending the retractor all the way out until a "click" is heard, next let the seat belt (webbing) retract into the retractor to the desired length and stop the belt at that point.

The retractor locks and will not let the belt lengthen at that point (only retract).

To cancel ALR mode and return the retractor to the ELR mode, just let the retractor retract the webbing all the way back into the retractor.

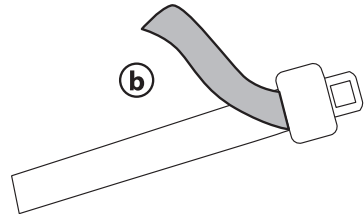
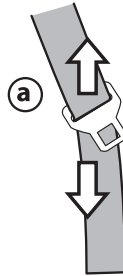

Vehicle seat belt overview

Lap/shoulder belt (3-point) with Switchable Locking Retractor (ELR → ALR) and free sliding latch plate.

This type of seat belt has a latch plate that moves freely along the belt. To activate ALR for child restraint installation, some vehicle models may require to pull the belt all the way out; some other vehicle models may require to pull the belt for a certain length (check Vehicle Owner's Manual for details).

For installation of this car seat, leave the seatbelt in ELR mode.

A locking clip may be required when the child seat is used without base (refer to [page 30](#)).

Use the lockoff clip integrated in the base when using this car seat with an accessory base.

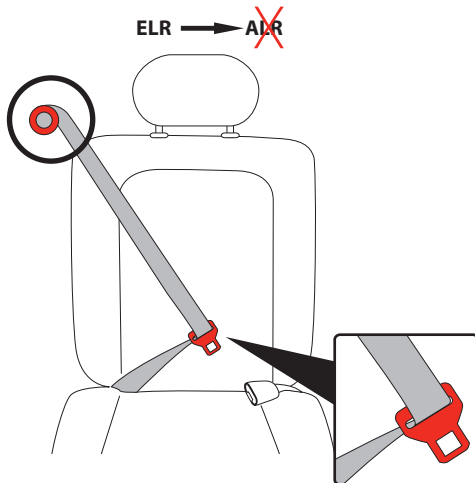

Vehicle seat belt overview

Lap/shoulder belt (3-point) with Emergency Locking Retractor (ELR) and with a locking latch plate. This type of belt can be adjusted by pulling/releasing the strap at the latch plate adjuster. Please refer to your Vehicle Owner's Manual for details.

A locking clip may be required when the child seat is used without base (refer to [page 30](#)).

Note: Some locking latch plates need to have the web positioned at the correct angle for proper locking. Make sure the latch plate properly locks when installing the car seat with a locking latch plate.

Note: some vehicles are equipped with switchable latch plate that can switch from a sliding type to a locking type. In this specific case, make sure that the latch plate is in a locking mode.

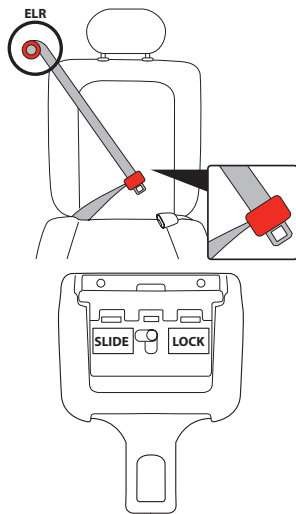

Vehicle seat belt overview

Lap/shoulder belt (3-point) with Emergency Locking Retractor (ELR) and free sliding latch plate. This type of seat belt has a latch plate that moves freely along the belt; it will only lock in an emergency (sudden stop or crash).

For installation of this car seat, leave the seatbelt in ELR mode.

A locking clip may be required when the child seat is used without base (refer to [page 30](#)).

Use the lockoff clip integrated in the base when using this car seat with an accessory base.

If additional help is needed, consult with a Child Passenger Safety Technician (CPST).

To locate a technician go to the website at <http://www.nhtsa.gov/cps/cpsfitting/index.cfm>

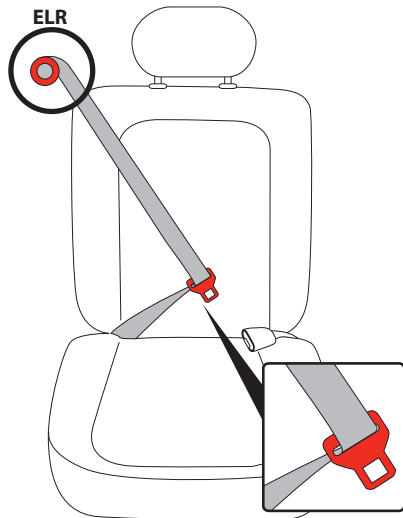

Vehicle seat belt overview

Lap / shoulder belt (3 point) with inflatable shoulder belt.

This type of seat belt is available on some recent vehicle models. The shoulder portion of this belt is equipped with an airbag inflatable in a crash.

For installation of this car seat with the base using this type of vehicle belt, please refer to [page 43](#).

Important note: DO NOT USE this car seat without base when installing with this type of vehicle belts.

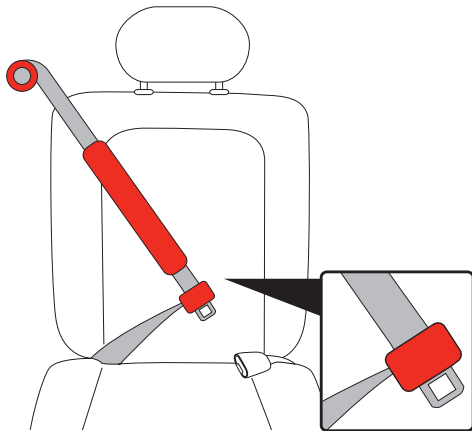

Vehicle seat belt overview

Lap belt (2-point) with a locking latch plate.

This type of belt can be adjusted by pulling/releasing the strap tail at the latch plate.

Some vehicles may have seatbelts with large rigid buckles. These designs may cause the installation to be troublesome and affect stability of the child restraint during normal use. Also, it may cause slack in the belt that may result in poor performance in case of a sudden stop or crash.

In this situation, try another seating position in the vehicle or consult your Vehicle Owner's Manual.

Please consult a certified child passenger safety technician for other installation options (www.nhtsa.gov/cps/cpsfitting/index.cfm).

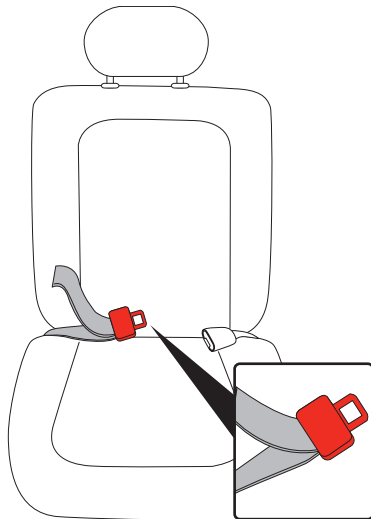

Vehicle seat belt overview

Lap belt (2-point) with Switchable Locking Retractor (ELR --> ALR). This type of seat belt has a latch plate that is sewn to the end of the belt. To activate ALR retractor for child seats installation, some vehicle models may require to pull the belt all the way through; some other vehicle models may require to pull the belt for a certain length (check Vehicle Owner's Manual for details). Tighten the belt around the seat feeding the belt back into the retractor. The belt will not extend unless you unbuckle the belt and repeat the operation from the beginning.

Lap belt (2-point) with Emergency Locking Retractor (ELR). This type of seat belt has a latch plate sewn at the end of the belt; it will only lock in an emergency (sudden stop or crash).

Important note: DO NOT USE this car seat with this belt or consult a certified child passenger safety technician for other installation options (www.nhtsa.gov/cps/cpsfitting/index.cfm).

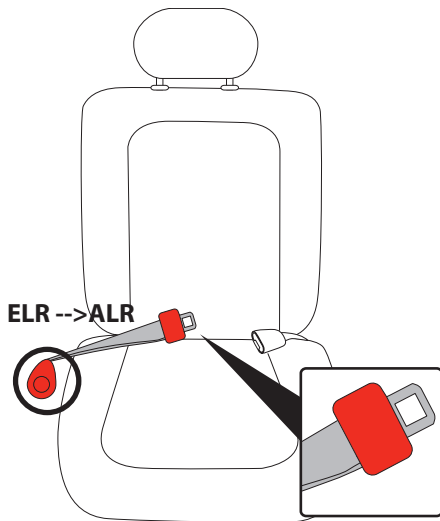

Non compatible seatbelt designs or seating positions

WARNING: do not use Primo Viaggio 4-35 **Urban Mobility** with the following vehicle belt design:

1. Lap/motorized shoulder belts.
Belts mounted on the door.

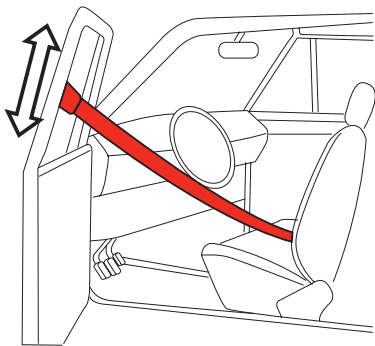

2. Side facing seats.

NO



NO

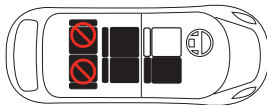

3. Rear facing seats.

4. Rotating seats unless they can be locked in forward facing direction.

NO



NEVER INSTALL
REAR-FACING IN
FRONT OF AN
ACTIVE AIRBAG



NO

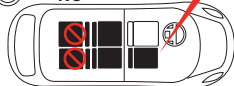

For your child's safety, always read your Vehicle Owner's Manual for further information.

Installing the Car Seat with Latch

This car seat is equipped with latch connectors integrated in the shell. Use of latch connectors is recommended for children whose weight is between 5 and 22 lbs (1.8 - 10 kg).

WARNING: Do not use latch connectors for children weighing more than 22 lbs (10 kg).

For children weighing more than 22 lbs (10 kg), store the latch connectors in their housing and attach the seat using the vehicle belts.

Undo the latch connectors from the seat shell pulling the red straps at the end of each connector (a).

Push on the adjuster button (1) and pull the connectors (2) at the same time to increase the length of the straps (b).

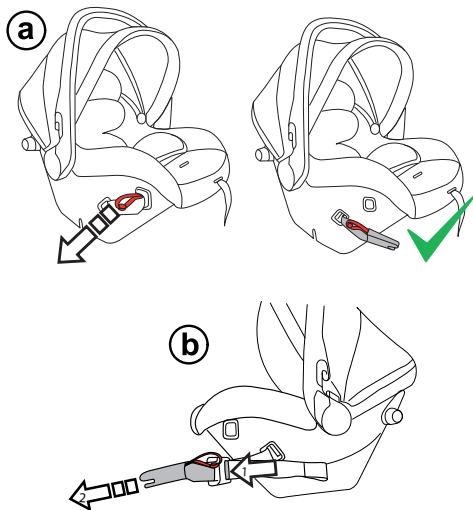

Installing the Car Seat with Latch

Make sure that your vehicle is parked on level ground when you install the seat. Position the restraint with the child in it on the seat, so that your child is facing the rear of the vehicle. Adjust the handle in the forward most position as shown (c). Any other position may injure your baby in an accident. To move the handle, press the gray buttons on the side of the handle, at the same time and rotate the handle.

Important! The seat must be parallel to the ground. Use the line drawn on the product as a reference: the line must be horizontal. If necessary, use rolled towels or pool noodles under the seat at vehicle seat crease (d).

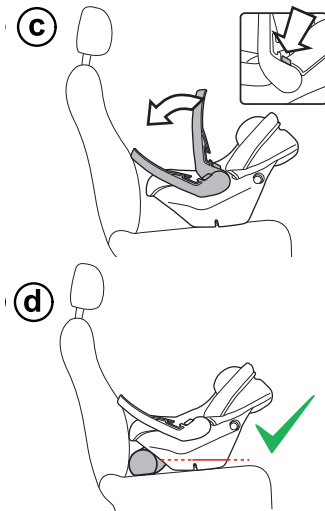

Installing the Car Seat with Latch

Push each latch onto the anchor bar located between your vehicle seat backrest and cushion. Press until you hear a click (e).

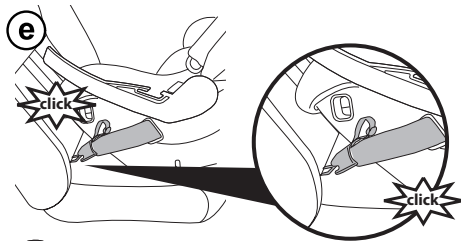

Tighten the car seat against the vehicle seat by pulling the free end of the latch strap; at the same time press down on the car seat and tighten further (f). If you can move it more than 1 inch (2,5 cm), tighten the belt further.

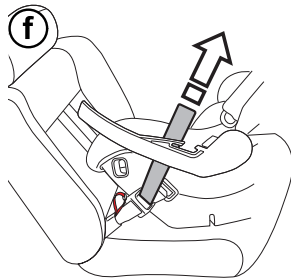

Installing the Car Seat with Latch

Picture show the product properly installed (g).

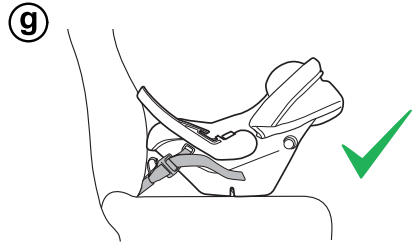

To remove the seat, rotate the handle in the carrying position (make sure that it is properly attached -1), pull the red strap on the latch connectors (2) and lift the car seat (h).

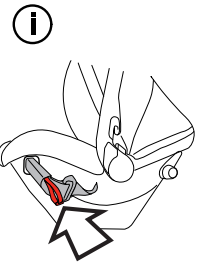
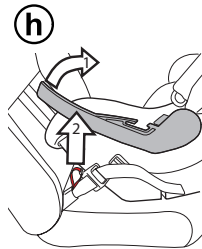

Store the connectors in their housing when not in use (i).

Installing the Car Seat with vehicle belts

Important! When installing the car seat with vehicle belts, make sure that the latch connectors are properly stored (refer to [page 26](#)).

Make sure that your vehicle is parked on level ground when you install the seat. Position the restraint with the child in it on the seat, so that your child is facing the rear of the vehicle. Adjust the handle in the forward most position as shown (a). Any other position may injure your baby in an accident. To move the handle, press the gray buttons on the side of the handle at the same time and rotate the handle.

Important! The seat must be parallel to the ground. Use the line drawn on the product as a reference: the line must be horizontal. If necessary, use rolled towels or pool noodles under the seat at vehicle seat crease (b).

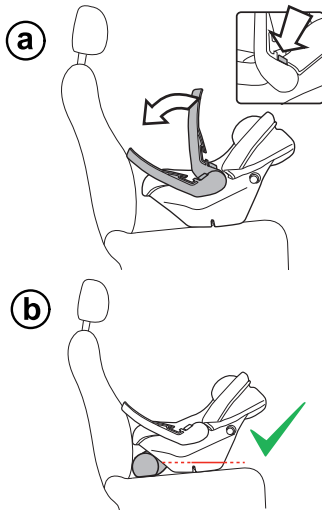

Installing the Car Seat with vehicle belts

Lap and shoulder belts.

Thread the lap belt through the slots on the handle and lock the latch plate into the buckle as shown (c). Pull the shoulder portion of the belt around the back of the seat (d).

Thread the shoulder belt into the slots in the back of the seat and pull it to tighten the restraint against the vehicle seat (e). Once the seat is tight, check that the red line on the side of the car seat is level with the ground (page 27).

Important! If the vehicle belt is not long enough, the restraint can be installed treading only the lap portion of the belt in the handle slots as show in the picture (f). If the vehicle belt is not equipped with a locking device, use of a locking clip is required (refer to [page 30](#) for additional details).

Warning! If you cannot get the belt tight enough, refer to your vehicle manual for instructions on how to secure the seat using the type of seat belt in your vehicle. Your baby is not safe riding in a loose car seat.

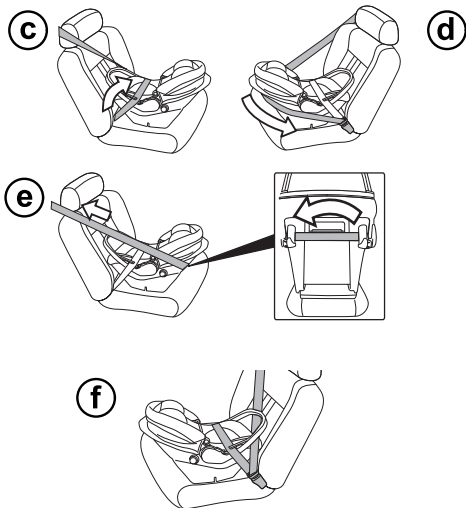

Installing the Car Seat with different Types of Seat Belts

Different Types of Lap Belts

Lap belts with Emergency Locking Retractors (ELR), Automatic Locking Retractors (ALR), and Switching Locking Retractors (SLR) look as shown (a). Consult your Vehicle Owner's Manual to determine which style you have.

Lap belts with locking latch plates look as shown (b).

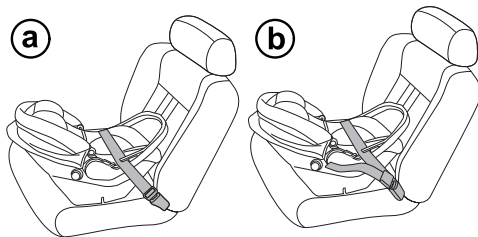

Lap belt only with an Emergency Locking Retractor If you have a lap belt (without shoulder strap) that locks only in an emergency (ELR), do not use it to secure this car seat. Please consult a certified Child Passenger Safety Technician for other installation options.

Use of a Locking Clip

Important! For different types of seat belts, please refer to [page 14](#) and on.

This car seat should not be installed on seat types shown on [page 22](#).

Should your vehicle belt need a locking clip, a standard one can be purchased in specialized retailers or through Peg Perego Customer Service.

To install the locking clip, hold the shoulder strap and lap belt together just above the buckle. Unbuckle the belt while holding the straps. Hook the locking clip around both straps as shown.

Leave 1/2 inch (1,3 cm) space between the clip and latch. Re-buckle the belt.

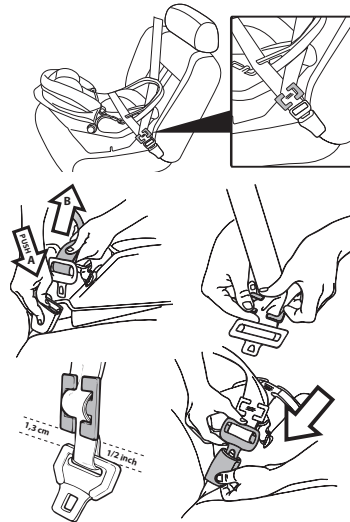

Use of accessory base

Primo Viaggio Urban Mobility can be used in conjunction with:

Base Primo Viaggio 4-35 Load Leg

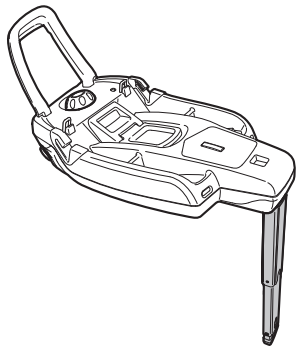

For installation instruction of this base, refer to pages 32-46

Base Viaggio 4-35

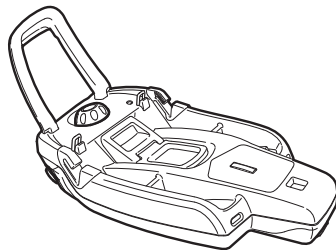

For installation instruction of this base, refer to pages 47-48

Use of accessory Base Primo Viaggio 4-35 Load Leg

Installation instruction with Base Primo Viaggio 4-35 Load Leg.

WARNING:

- When using this car seat with **Base Latch Load Leg 4-35**, first install the base, and then install the car seat on the base.
- The load leg guarantees a more stable installation and less rotation of the seat in a frontal collision.
- Do not use the load leg if the adjustable foot is not in contact with the vehicle floor.
- If your vehicle has a floor panel that is designed to fold/open, please check your Owner's Vehicle Manual to see if a load leg is allowed.
- If you use a lap belt or lap/shoulder belt to install the base, you must use a seat belt that locks in place. Please refer to your Owner's Vehicle Manual for additional information. You may need to use a locking clip, not provided with this seat.

There are two ways to install the base:

- 1• USING LATCH SYSTEM.** If your car has “universal lower anchors” (page 15), you can install the child car seat using the LATCH system instructions on [page 36](#).



Important! In addition to this manual reading, check your vehicle manual for child restraint use, Latch System location or vehicle belt information.

- 2• USING A STANDARD LAP BELT OR LAP/SHOULDER BELT.** If your car does not have universal lower anchors, install the child car seat using the instructions for lap or lap/shoulder belt on [page 40](#).

Important! Read your vehicle manual for instructions on where to best install a child car seat in your vehicle.

Use of accessory base

Before use, snap fit the anti-rebound bar into the base as shown in the picture.

Check that the bar is properly installed by pulling on top of it trying to detach the bar from the base.

IMPORTANT NOTE: the anti rebound bar provides extra protection in case of a rear collision or during the movement of the seat in a crash. Always assemble it properly.

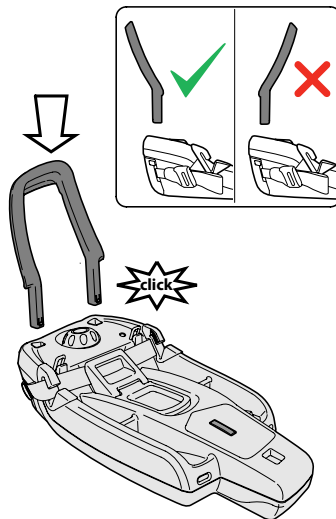

Using the load leg

Base Primo Viaggio 4-35 Load Leg is equipped with a load leg. The leg is folded under the base for transportation purposes. **Always deploy the load leg before leaning the car seat on the vehicle seat.**



Use of the leg provides a more stable platform in normal use and reduces rotation of the seat in a frontal collision. To use the leg, deploy it from the bottom of the base (a) until it clicks in position (b). The visual indicator will show the symbol.



Adjust the foot pulling the button as shown in the picture (c). Make sure that the leg is locked and that the foot touches the floor of the vehicle. To fold the leg, shorten the foot and tuck the leg under the base. The visual indicator will show the symbol.

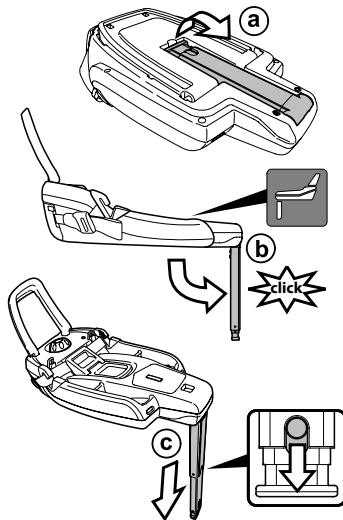

How to level the base in the vehicle

Make sure that your vehicle is parked on level ground. Position the base rear facing in the back seat of your vehicle.

Turn the knob left or right to adjust the base foot (a).

Check the level indicator on the top surface of the base and further rotate the knob to make sure that you reach the proper angle (b). Follow the visual instructions placed on the side of the indicator in order to set the angle corresponding to the weight of your child.

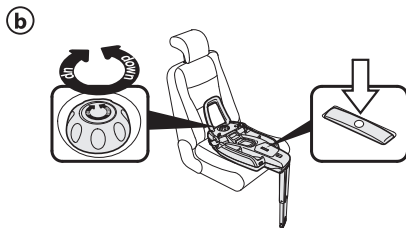
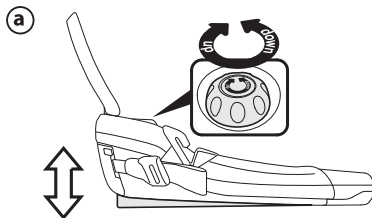

How to install the Base using the LATCH SYSTEM

Open the lock off clip as shown in the picture (a). Open the front cover as shown in the picture (b). Remove the two latches from their housings; push on the red button and pull the connector out. Push on the adjuster button to lengthen the strap as shown in the picture (c).

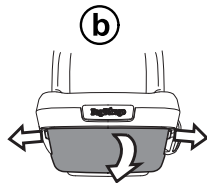
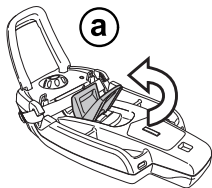

Deploy the load leg until it clicks in the down position and lean the base on the seat (d). Level the base following the procedure at [page 35](#).

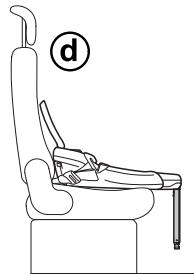

How to install the Base using the LATCH SYSTEM

Push each latch onto the anchor bar located between your vehicle seat backrest and cushion. Press until you hear a click (e).

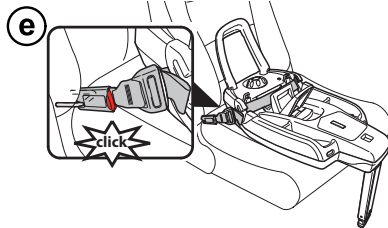

Tighten the base against the seat by pulling the free end of the latch strap; at the same time press down on the base with your body weight and tighten further (g). Push and pull on the base. If you can move it more than 1 inch (2,5 cm), tighten the belt further.

(f)

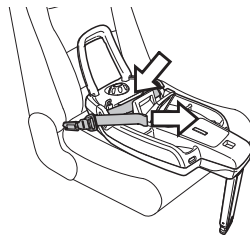

How to install the Base using the LATCH SYSTEM

Adjust the foot of the load leg.

To move the foot up and down push the button down as in picture and move the foot in the desired position, making sure that the pin locks in place

The correct adjustment of the foot is when the foot touches the floor of the vehicle. A thin space is allowed between the base and the edge of the seat.

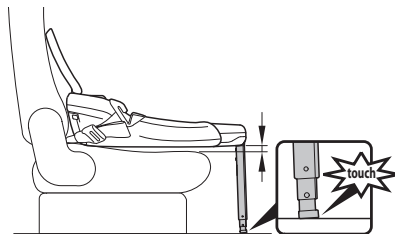
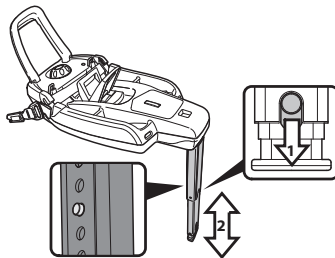

How to install the Base using the LATCH SYSTEM

Close the Right Tight lockoff clip by pressing the lever as shown in the picture with an audible click.



Now check the level indicator again. It gives the proper backrest angle depending on the weight of your child. Make sure that the bubble is in the correct area (i).

Now that you have installed the base, go to [page 45](#).

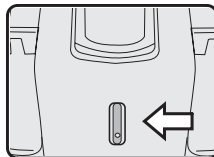
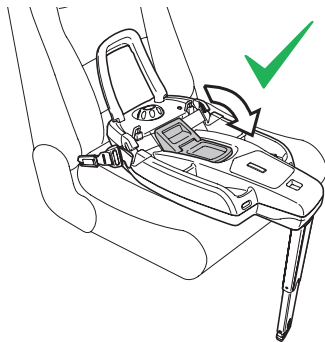

How to install the Base using your VEHICLE SEAT BELT

Important! Not all the seat belts work in the same way. To make sure that the car seat is properly installed using your seat belts, read your Vehicle Owner's Manual. It will suggest proper installation of a child car seat.

This section refers to base installation using a common lap/shoulder belt with sliding latch plate and ELR or SLR retractor (page 14 for additional details).

Make sure that your vehicle is parked on level ground. Position the base rear facing in the back seat of your vehicle.

Turn the knob left or right to adjust the base foot (a). Check the level indicator on the top surface of the base and further rotate the knob to make sure that you reach the proper angle (b). Follow the visual instructions placed on the side of the indicator in order to set the angle corresponding to the weight of your child.

Keep the latch connectors stored in their housing. Open the lockoff clip as shown in the picture (c).

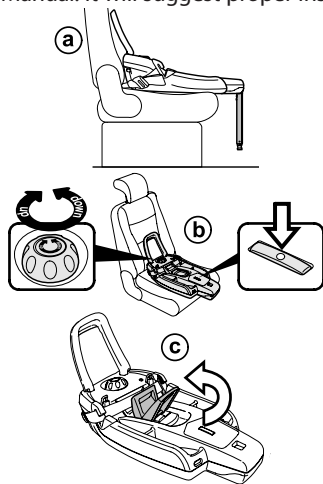

How to install the Base using your VEHICLE SEAT BELT

Thread the lap portion of the belt through the slots on the base (d) and lock the latch plate into the buckle as shown (e). Press down on the base with your body weight and pull the shoulder strap as shown (f). Take the shoulder portion of the belt and tread it through the openings again (g).

Close the Right Tight lockoff clip by pressing the lever as shown in the picture (h) with an audible click. Push and pull on the base. If you can move the base more than 1 inch (2,5 cm), tighten the belt further. Check the level indicator. If the bubble has moved outside of the desired area, turn the knob until it is back within the correct area. You may need to loosen the strap slightly to do this.

Warning! If you cannot get the belt tight enough, refer to your vehicle manual for instructions on how to secure the base using the type of seat belt in your vehicle. Your baby is not safe riding in a loose car seat.

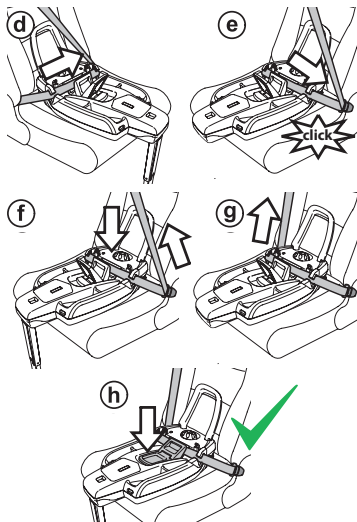

How to install the Base using your VEHICLE SEAT BELT

Adjust the foot of the load leg. To move the foot up and down push the button down as in picture and move the foot in the desired position, making sure that the pin locks in place

The correct adjustment of the foot is when the foot touches the floor of the vehicle. A thin space is allowed between the base and the edge of the seat.

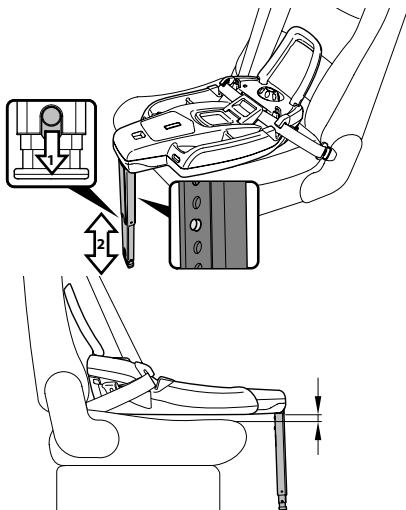

How to install the Base using a lap/shoulder INFLATABLE SHOULDER BELT

Thread the lap portion of the belt through the slots on the base (a) and lock the latch plate into the buckle as shown (b). Press down on the base with your body weight and pull the shoulder strap up as shown (c).

Close the Right Tight lockoff clip by pressing the lever as shown in the picture (c) with an audible click. Leave the shoulder portion of the belt out of the base as shown in the picture (d).

Push and pull on the base. If you can move the base more than 1 inch (2,5 cm), tighten the belt further. Check the level indicator. If the bubble has moved outside of the desired area, turn the knob until it is back within the correct area. You may need to loosen the strap slightly to do this.

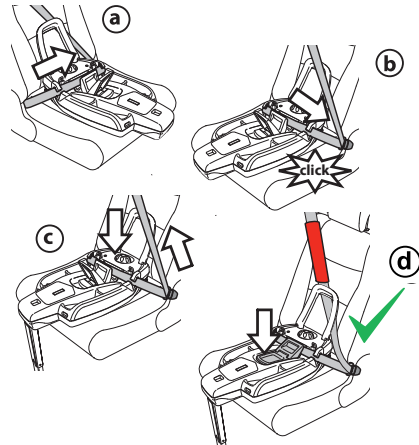

Warning! If you cannot get the belt tight enough, refer to your Vehicle Owner's Manual or call Peg Perego USA Customer Service at 1-800-671-1701 for additional instructions. Your baby is not safe riding in a loose car seat.

Installing the Base with different Types of Seat Belts

Different Types of Lap Belts

Lap belts with Emergency Locking Retractors (ELR), Automatic Locking Retractors (ALR), and Switching Locking Retractors (SLR) look as shown (a). Consult your Vehicle Owner's Manual to determine which style you have.

Lap belts with locking latch plates look as shown (b).

Lap belt only with an Emergency Locking Retractor If you have a lap belt (without shoulder strap) that locks only in an emergency (ELR), do not use it to secure this car seat. Please consult a certified Child Passenger Safety Technician for other installation options.

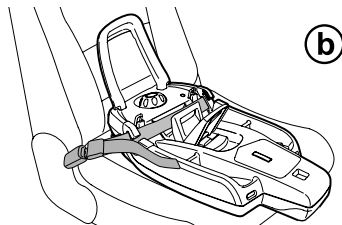
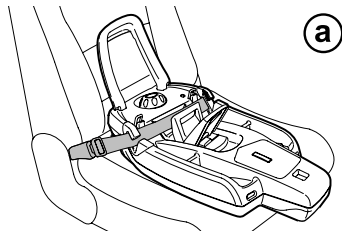

Important! If the base is used without the load leg, leave the load leg tucked under the base and install it using vehicle belt only as explained in the previous sector.

Installing the Car Seat on the Base

Now that you have installed the base in your vehicle, you are ready to install the car seat on the base.

Holding the car seat by the handle, align it over the base and press it rear facing on the base until you hear the click (a). You will not be able to move the car seat if it is properly locked in place.

Check that the red/green indicators, located at the rear of the base, are in the green position (b).

Important! Newborn children should be properly reclined. If the seat reclines too much, your baby can be ejected from the seat in an accident. If too upright, it can cause breathing problems.

Once the seat is installed on the base, check if the bubble has moved from the original position. In case re-adjust the seat until the bubble is in the correct position.



Use of accessory Base Primo Viaggio 4-35

Installation instruction with Base Primo Viaggio 4-35.

Before use, snap fit the anti-rebound bar into the base as shown in the picture.

Check that the bar is properly installed by pulling on top of it trying to detach the bar from the base.

IMPORTANT NOTE: the anti rebound bar provides extra protection in case of a rear collision or during the movement of the seat in a crash. Always assemble it properly.

When installing the base with Latch, remove the two anchor latches from their housings. The latches are on the side of the base. Press the red button on top of the latch connector (a) and pull it out of its housing (b). Repeat on the other side.

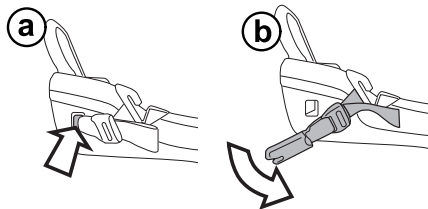
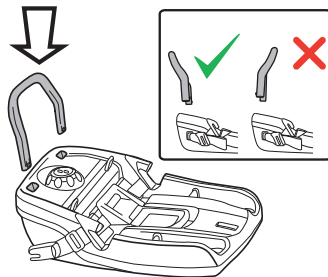

Use of accessory Base Primo Viaggio 4-35

Installation using latch:

- make sure that the anti-rebound bar is properly fitted (page 46)
- undo latch connectors (page 46)
- lean the base rearfacing on the seat and level it (page 35)
- attach the base to the lower anchor using latch connectors (page 37)
- close the Right Tight lockoff clip and check angle indicator (page 39)

Installation using vehicle belts:

- make sure that the anti-rebound bar is properly fitted (page 46)
- lean the base rearfacing on the seat and level it (page 40)
- attach the base with the vehicle belts (follow the sequence at page 41 or 43 or 44 depending on the vehicle belt type)
- close the Right Tight lockoff clip and check angle indicator (page 39)

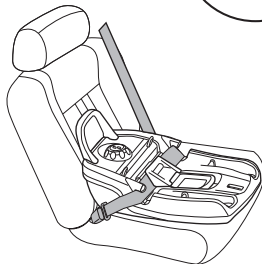
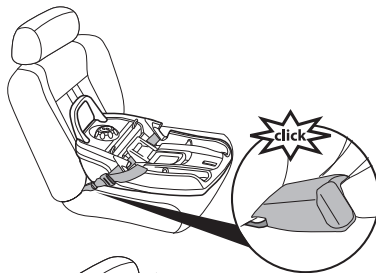

Installing the Car Seat on the Base

It is recommended to adjust the handle so that it rests at the top edge of the car seat as shown. To rotate the handle, press the squared buttons (located on each side of the handle where it attaches to the seat) and rotate it to the required position (a).

To remove the car seat, move the handle to the upright position. Place your hand on the top of the seat back and pull up on the release lever with your fingers (b).
Note: Pulling near the center of the lever provides the easiest release.

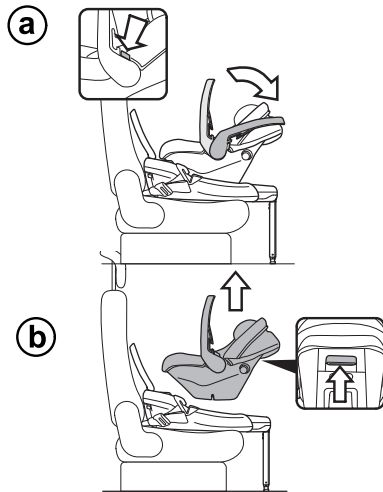

How to buckle your baby into the Car Seat

This restraint uses a 5-point harness system to secure your baby into the car seat.

Undo the chest clip, pressing the button on the clip and pulling apart as shown (a).

Undo the latch plates, pressing the red button and pulling the latches up (b).

Push and hold the harness adjuster button located in a slot at child's feet and pull the shoulder belts out (c).

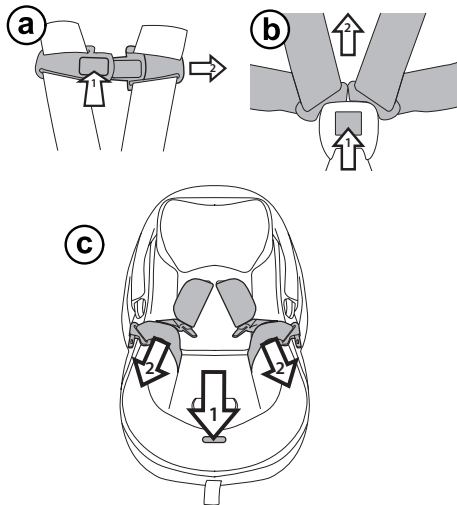

How to buckle your baby into the Car Seat

Lay the shoulder straps to the side to make room for your baby; use the side bands to keep the harness open as shown in the picture (d).

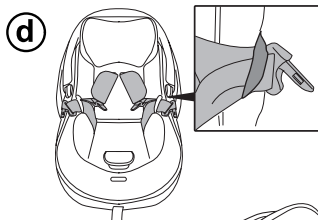

Put your baby in the car seat with the bottom and back flat against the child restraint. Bring the two shoulder straps over your baby's shoulders. Make sure the straps are not twisted behind the backrest or over your baby's chest (e).

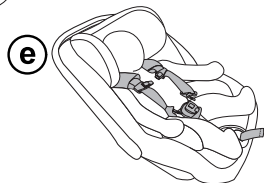

Insert both latch plates into the buckle until you hear them click. Latch the two chest clips together (f).

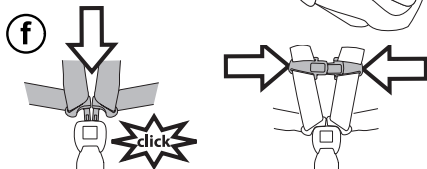

How to buckle your baby into the Car Seat

Adjust the chest clip to the arm pit level. To tighten the harness, pull the adjuster strap at the bottom of the seat until the strap is snug. Tuck the loose end of the adjuster strap under the seat padding. Pull on straps to make sure that both plates are latched securely (g).

IMPORTANT NOTE: You may need to adjust the shoulder height. See how to raise or lower the shoulder straps at [page 54](#).

Make sure you leave one finger width between the harness and your baby's collar bone or try to pinch the webbing as shown in the picture (h). If you can easily pinch the straps the harness may be tightened further.

g

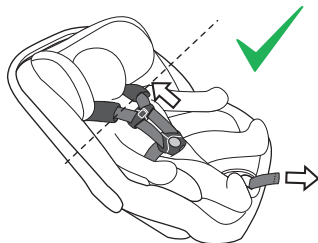

h

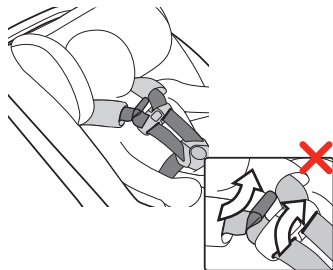

How to buckle your baby into the Car Seat

To loosen the harness, press and hold the harness adjuster button inside the slot located at your baby's feet, and pull the top harness as shown (i).

Important! A snug strap should not allow any slack. It lies in a relatively straight line without sagging. It does not press on the child's flesh or push the child's body into an unnatural position.

(i)

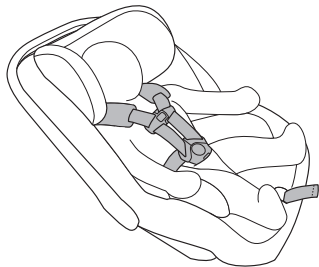
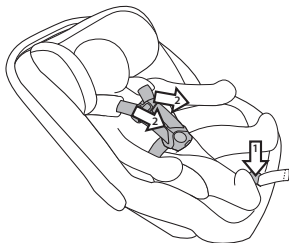

How to buckle your baby into the Car Seat

Important! In winter time do not fasten the child in the car seat wearing bulky clothes or placing extra blankets between the body and the harness. This will result in a poor belt installation that may have severe consequences in case of a collision.

To provide extra weather protection use a blanket over the harness or use approved Peg Perego accessories.

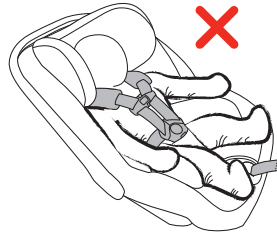

How to raise or lower the Shoulder Straps

This car seat is fitted with a sliding harness plate to make strap adjustment easy and safe. Removing the shoulder straps and threading through slots is not required on this seat (a).

To raise or lower the harness plate, push the button on the bottom of it and at the same time pull or push the plate to adjust at the desired position (b).

There are 6 positions to choose from (c).

(a)

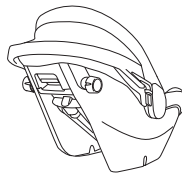

(b)

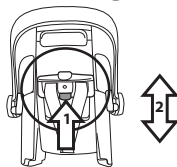

(c)

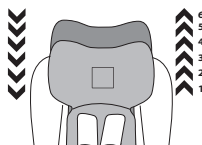

How to raise or lower the Shoulder Straps

The correct height of the side protection panel is when the shoulder strap slots are located just below shoulder level (green area), as shown in the picture (d). Make sure belts are not in the red area.

Important! This restraint is designed for children up to 32 inches (81.3 cm) in length. The top of the child head should not exceed the top of the seat back by at least one inch (2.5 cm) as shown in the picture (e). With the growing child, additional cushions can be removed (see [page 57](#) for additional information).

Important! Make sure that the chest harness and all the straps are flat and not twisted on the back or the front of the car seat.

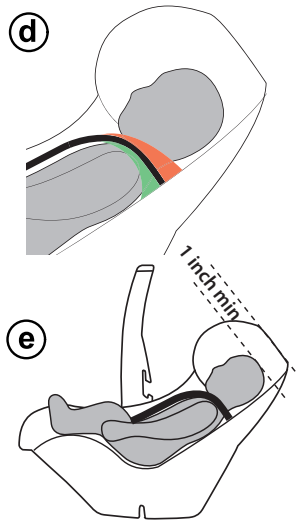

Kinetic Pods

The seat is fitted with Kinetic Pods, to ensure greater safety in the event of a side impact. Once you have positioned the seat in the car, pull out COMPLETELY the Kinetic Pod situated on the side FACING THE CAR DOOR by turning it clockwise (a). To return the Pod to its initial position, rotate it counter-clockwise (b).

IMPORTANT: Make sure the Kinetic Pod situated on the side facing the inside of the car is never pulled out.

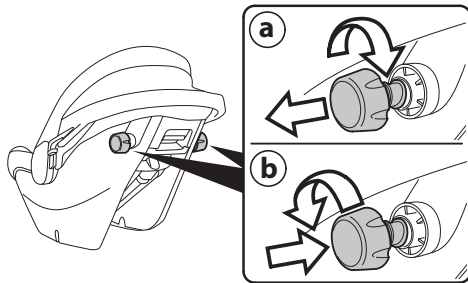

Dual Cushion System

This car seat is equipped with a Dual Stage Cushion System consisting of a first stage (1) and a second stage cushion (2).

If your baby is very tiny, cushion 1 can be used in conjunction with cushion 2 as shown (a).

The first stage cushion provides extra back support, allowing the head of your child to stay flat properly, avoiding breathing difficulty.

Additionally, the second stage cushion makes sure that your child does not slip down and his head is fully supported between the side impact protection wings (b).

Important! The Dual Stage Cushion System may be used from birth up to about 20 lbs (9 kg) or when the torso of your baby fully occupies the space between the crotch strap and the shoulder slots.

To remove the cushion, refer to [page 62](#).

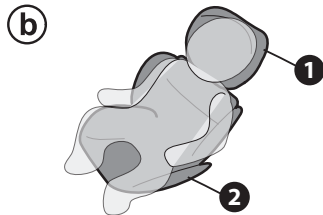
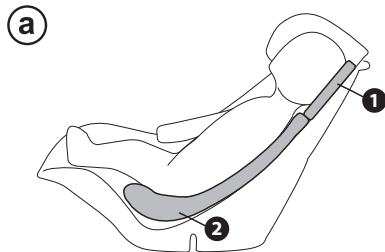

Using the Car Seat outside the Vehicle

This unit can be used as an infant carrier. The special shell shape is designed for rocking your baby.

To rock your baby, move the handle into the up position as shown (a).

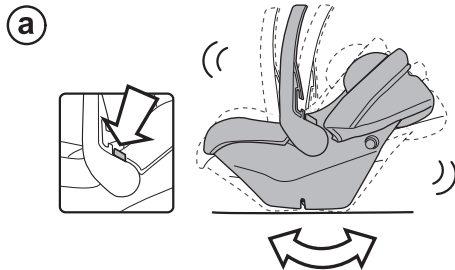

To prevent rocking, lock the handle behind the backrest (b).

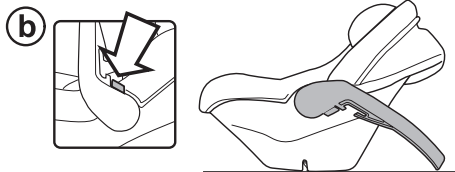

Using the Car Seat outside the Vehicle

The hood provides shade for your baby (c).

To turn the hood into a Pagoda Hood, open the zip (d) and lower it (e)

To attach the hood, push the hood latches into the slots on the seat shell as shown (f). Secure the elastic fasteners to the shell as shown in the picture. To open the hood, pull the frame until it clicks open.

To remove the hood, remove the fasteners from the seat shell and pull the side latches as shown in the picture (g).

Warning! The hood must not be used to lift the safety seat because it might detach.

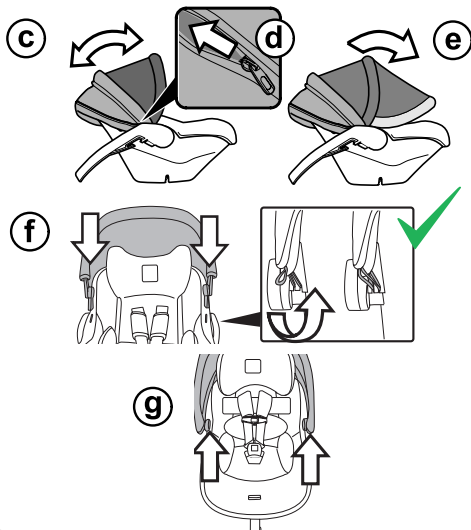

How to Use the Car Seat on Aircraft

This unit is certified for aircraft use.

Position the restraint on the seat, adjust the handle in the forward most position as shown. Any other position may injure your baby in an accident. To move the handle, press the gray buttons on the sides of the handle at the same time and push the handle.

Adjust the restraint on the seat. Check the red line to see that the base is level with the ground. Thread the lap belt through the slots on the handle seat and lock the latch plate into the buckle.

Pull the strap to tighten the seat belt. Press down on the seat with your body weight and pull the strap tighter. Once the seat is tight, check that the red line on the side of the car seat is level with the ground.

Important! Use only on forward facing seats. If the restraint can not be properly secured ask for flight attendant help.

Important! Do not use the base to install the restraint on an aircraft.

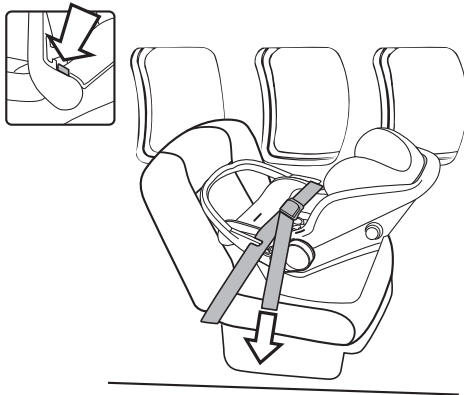

Cleaning and Maintenance

This unit needs minimal maintenance.

Keep all moving parts clean.

Clean the plastic parts often with a damp cloth. Do not use solvents or harsh products.

Brush the fabric parts to remove dust.

Protect the product against snow, water, and rain. Constant exposure to sunlight can change the colors in the material. Sun can also make the seat very hot. Be sure it is cool before putting your baby in the seat.

Warning! Excessive exposure to the sun for long periods of time can make the plastic brittle.

Store product in a dry area.

Warning! Do not use or purchase this restraint 7 (seven) years after the production date labelled on the seat or shell.

MAINTENANCE OF THE PADDING

Brush the fabric parts to remove dust.

To wash this upholstery, follow the instructions written on the product label (see below).

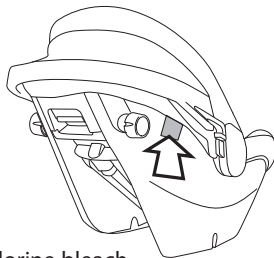

Do not use chlorine bleach.

Do not iron.

Do not dry clean.

Do not remove stains with solvents.

Do not tumble dry.

How to wash the chair padding - Cover removal

Open the harness following procedure at [page 49](#).

Remove the Dual Stage Cushion by pulling the bottom cushion through the crotch strap opening (a).

First Stage Cushion and Dual Stage Cushion are snap buttoned together and can be separated for ease of maintenance.

To remove the hood, remove the fasteners from the seat shell (as shown in picture b) and pull the hood away from the shell .

(a)

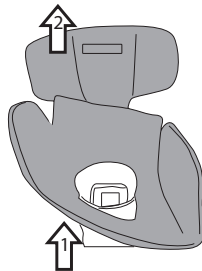

(b)

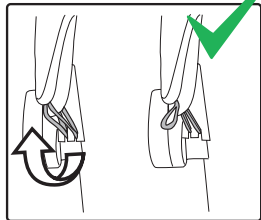

How to wash the chair padding - Cover removal

Turn the seat upside down and remove the shoulder belts from the splitter plate (c).

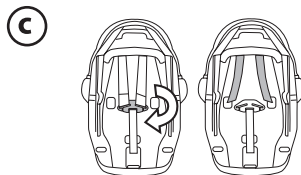

Slip the side belts through the slots in the cover (d).

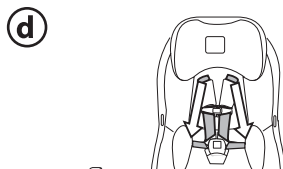

Undo the elastic bands under the handle as shown in the picture (e) and remove the seat cover starting from the crotch strap (f).

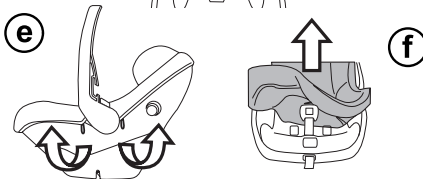

How to wash the chair padding - Cover removal

Remove the seat cover and the head panel cover as shown in the sequence (g,h).

Important! the shell and the head panel are fully lined with EPS. Pay attention when the covers are removed in order to avoid breaking these parts.

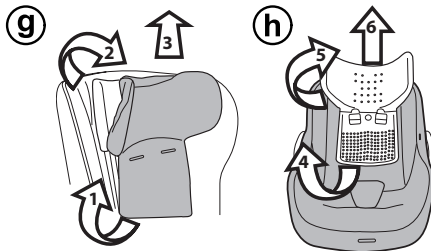

How to wash the chair padding - Refitting

Slide the padding on (a) following the sequence, as shown:

- slide the cover on from the top (1)
- allow the head panel to pass entirely through the large opening (2)
- then slide the cover under the plastic panel of the headrest (3).

Let the waist belts pass through the side openings of the cover (b).

Put the head panel cover on (c) starting from one wing and then doing the second. Be careful doing this operation.

Slip the crotch strap through the opening in the cover (d) and insert it into the leg divider (e).

Refit the four elastic bands to the side of the shell (f).

Thread the shoulder straps back in the head panel openings (g).

Connect the shoulder straps to the splitter plate (h).

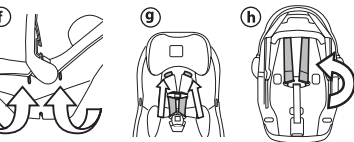
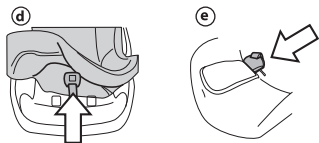
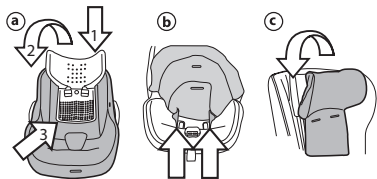

How to wash the chair padding - Refitting

Insert the stage 2 cushion back in place through the crotch slot (i). If you need to put the stage 1 cushion back in place make sure to fasten the side buttons as shown in the picture (j).

(i)

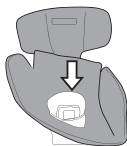

(j)

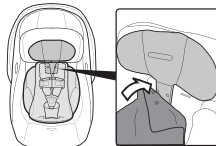

To attach the hood, push the hood latch into the slot on the seat shell as shown (k). Secure the elastic fasteners to the shell as shown in the picture.

(k)

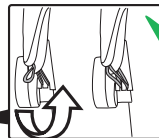
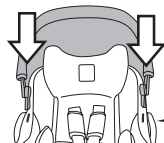

Replacement Parts

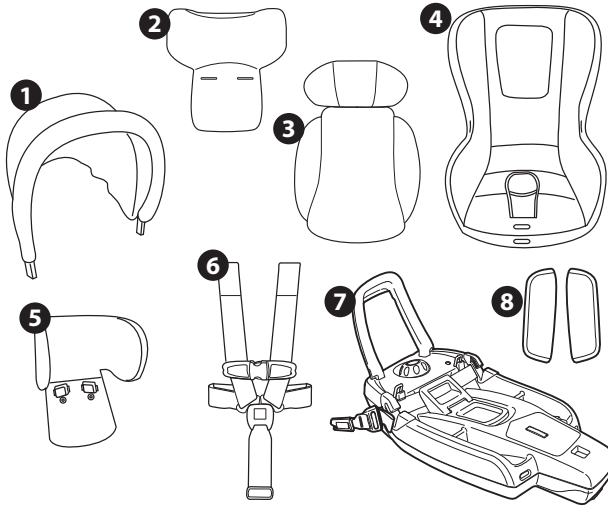

- 1) BCAVNKNA*
- 2) BPTVNKNA*
- 3) BRIVNKNA*
- 4) BSAVNKUS*
- 5) ASPI0210NFGZ
- 6) MUCI150GR
- 7) IAKADJBA01USNF
- 8) BSPNIDNA*

NOTE: Spare parts available in different colors* to be specified when ordering.

NOTE: A Tether is not a component of a rear facing only car seat.

EN English

Declaration of conformity

Product name

PRIMO VIAGGIO 4-35 NIDO K

Product reference number

IMPV07•

Reference Standards (origin)

FMVSS 571-213 (USA)

Declaration of conformity

PegPerego S.p.A. declares, under its own responsibility, that the item in question has undergone a series of internal tests and has been certified by external independent laboratories, in compliance with current legislation.

Date and place of issue

Arcore, July 2023

PegPerego S.p.A.
via De Gasperi, 50
20862 Arcore (MB), ITALY

ES Español

Declaración de conformidad

Denominación del producto

PRIMO VIAGGIO 4-35 NIDO K

Código de identificación del producto

IMPV07•

Normativas de referencia (origen)

FMVSS 571-213 (USA)

Declaración de conformidad

PegPerego S.p.A. declara bajo su propia responsabilidad que el artículo considerado ha sido sometido a ensayos propios y ha sido certificado por laboratorios externos e independientes de conformidad con las normas vigentes.

Fecha y lugar de expedición

Arcore, julio 2023

PegPerego S.p.A.
Via De Gasperi, 50
20862 Arcore (MB), ITALY